

MSP430 Egel kit vsn 2

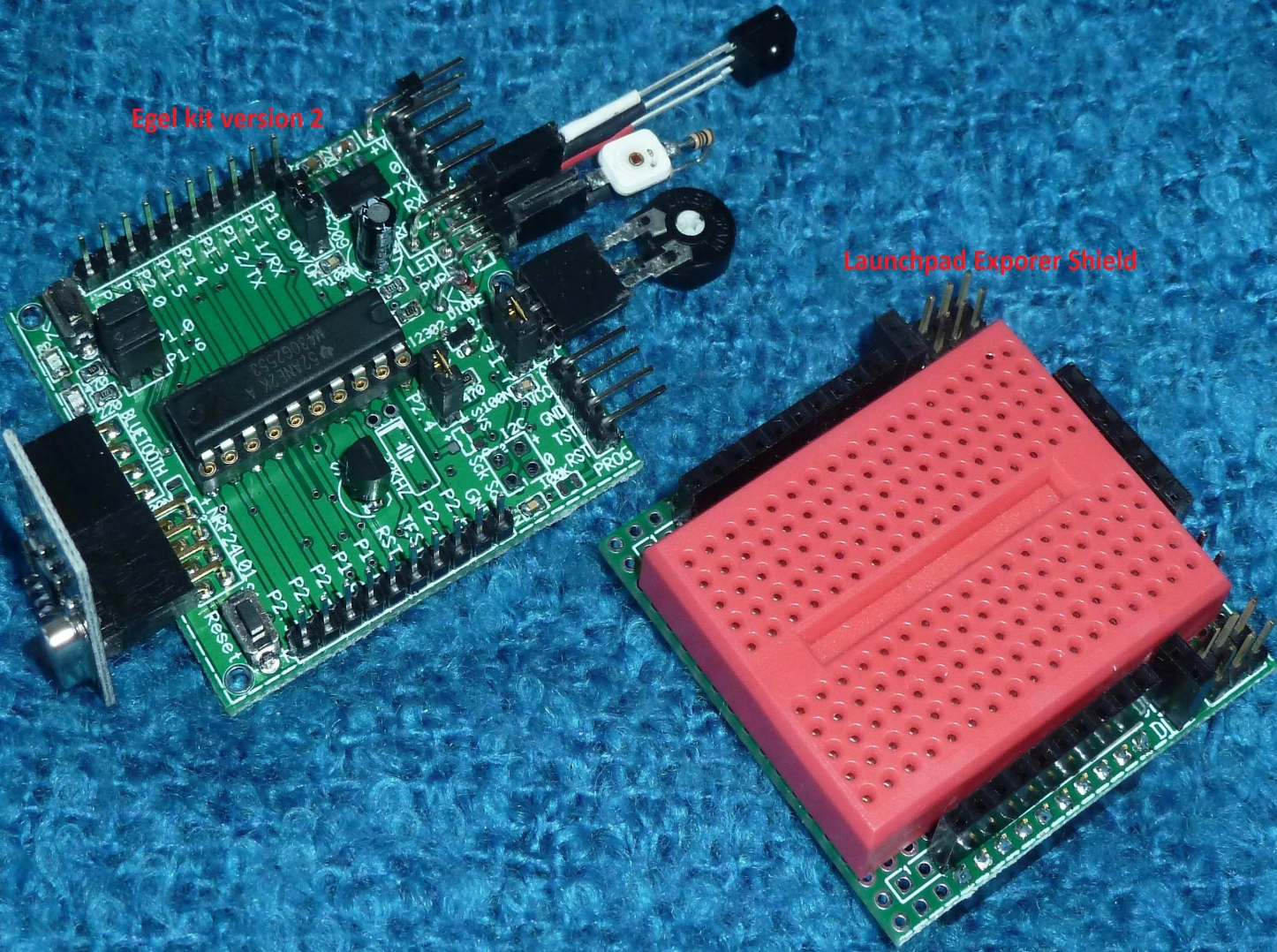

Egel kit version 2

Launchpad Explorer Shield

MSP430 Egel kit IO.txt

MSP430 Egel kit with MSP430G2553

Bit	Function

P1.0	- Led Red
P1.1	- RXD
P1.2	- TXD
P1.3	- S2/ADC
P1.4	- STE/nRF-CSN
P1.5	- CLK/nRF-SCK
P1.6	- SCL/nRF-MISO/Led Green
P1.7	- SDA/nRF-MOSI/ADC
P2.0	- RC5-input
P2.1	- IR-Led
P2.2	- Free
P2.3	- nRF-CE
P2.4	- PWM/Relais
P2.5	- nRF-IRQ
P2.6	- Xout
P2.7	- Xin

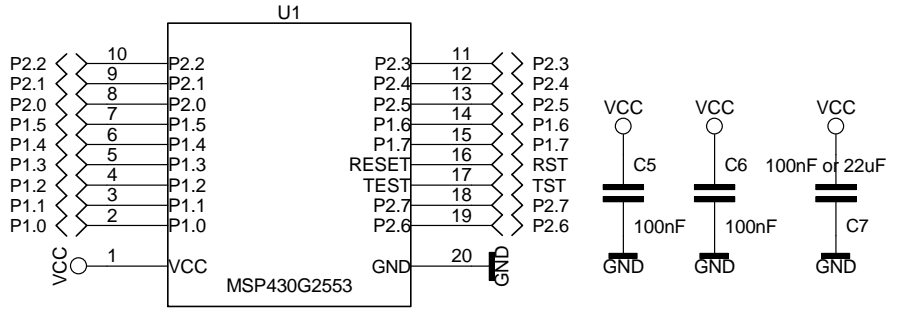
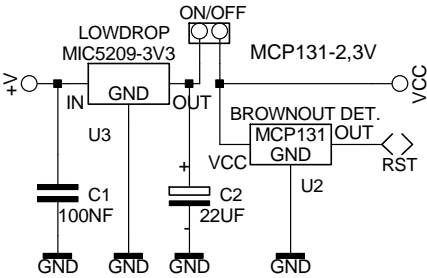
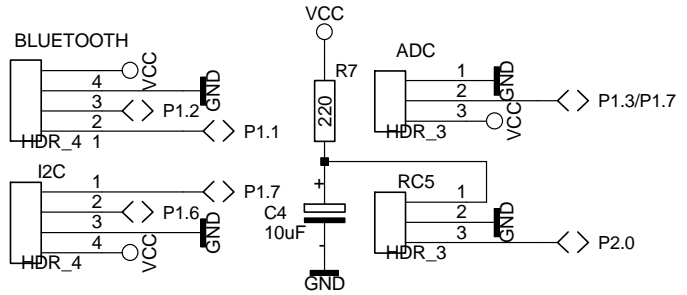
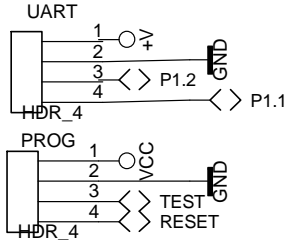
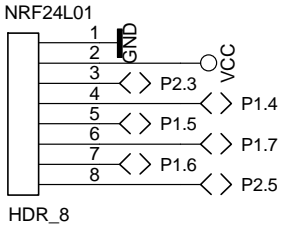

C7 MUST BE 22UF WHEN USING NRF24L01+

MSP430 EGEL KIT - V2

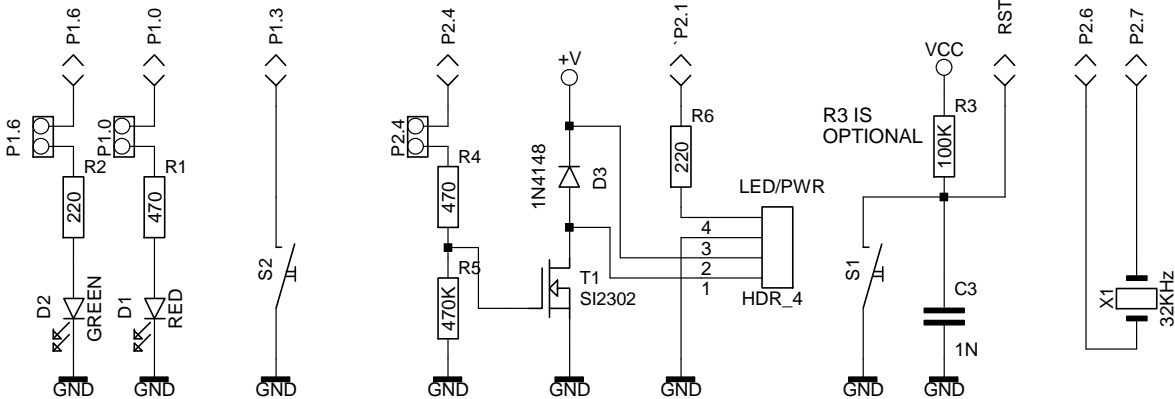

Egel kit vsn 2, Bill of materials

Number	Components
1	MIC5209-33
1	TMS2302-mosfet "A2SHB"
1	MSP430G2553
1	1N4148
1	Led red-0603
1	Led green-0603
1	32kHz-xtal
1	MCP131-240
1	10UF-10V
6	100nF-0603
1	1nF-0603
1	22uF-0603
3	220-0603 "221"
6	470-0603 "471"
1	470K-0603 "474"
2	Switch
1	Dil-20
4	1x10-female
1	1x2-female
1	1x4-female angle
1	2x4-female angle
1	1x29-male (in pieces)
1	1x11-male-angle
2	2x2-male-angle
1	3x1-male-angle
2	2x1-male-angle
2	2x3-male
5	Jumper
1	SYB-170 breadboard
1	Led board
1	Set wires

The Egel kit consists of the following components:

- USB RS232/Power cable
- Led board
- Two circuit boards
- Mini breadboard
- A lot of connectors
- Bag with loose (SMD) parts
- Processor MSP430G2553
- Two pushbuttons
- A few wires

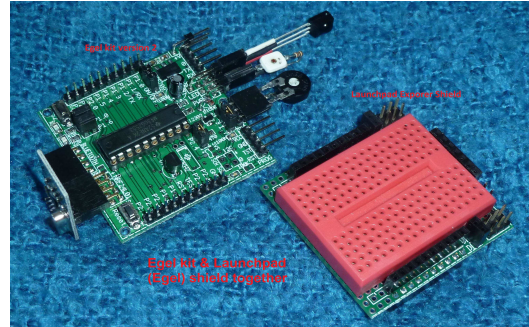

Used solder paste (flow control agent or flux):

<http://www.reichelt.de/Flux-Solder-Paste/ULF-10/3/index.html?&ACTION=3&LA=2&ARTICLE=98664&GROUPID=4132&artnr=ULF+10>
<https://www.conrad.nl/nl/soldeervloeimiddel-stannol-loeffett-100-g-inhoud-100-g-f-sw-21-826102.html>
<https://www.conrad.nl/nl/soldeer pasta-stannol-165018-inhoud-50-g-f-sw-26-588206.html>

Soldering of SMD components:

Use a clean solder iron of about 40 Watt.
The tip of the solder iron may be a little blunt, like a small screwdriver.
Use a well lighted loupe. A strong reading glasses or two weaker ones worn over each other does wonders too.

Use enough solder paste or an other kind of flux,
place the right component (take care) and center it.
Do a drop of solder on the tip.

Its is usefull to have a little longer nails. With your nail you may fix the part to the board. If the part moves try it again and again until it succeeds.

The put the tip with solder on it to the first pad.
You see the solder flow from the tip to the component.
See this video: <https://www.youtube.com/watch?v=fqHleZjTaH8>

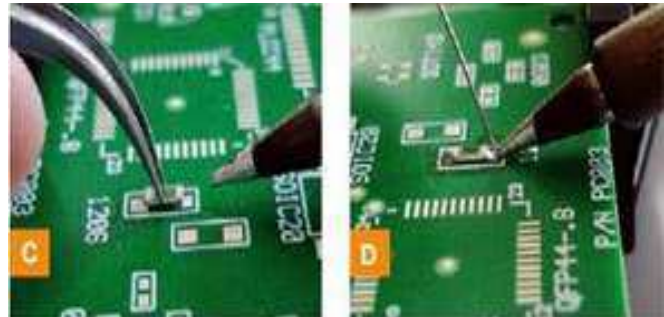

Assembly

On both boards there are some SMD components.
Look carefully to the drawings for a correct placement.

- 1) Solder first all SMD components.
- 2) Always do all components of the same type and value.
SMD parts tend to look all the same!
Do the resistors first, then the capacitors.
- 3) Next the TMS2302-mosfet and both leds, then the MIC5209.
- 4) The remaining parts are easy. The best way is always to mount the lower parts first, etc.

Finally place the CPU correct in the 20-pins socket.
Do a final optical check for solder errors and correct possible problems.
Connect the wires from the USB cable to the PWR-connector:

+ = red, 0 = black, TX = white and RX = green.

Take care here, finally connect the USB-plug to the PC.

The PC loads the correct driver (PL2303TA Prolific driver).

noForth is preloaded in the MSP430G2553, on the Egel kit both leds will light up shortly signalling startup.

Then start a standard terminal program like Teraterm or Coolterm.
Select the correct RS232 connection & baudrate and type enter.
When all works fine noForth answers with OK. Now type COLD and the startup message should appear.

Good luck.

Placement (SMD) components-1

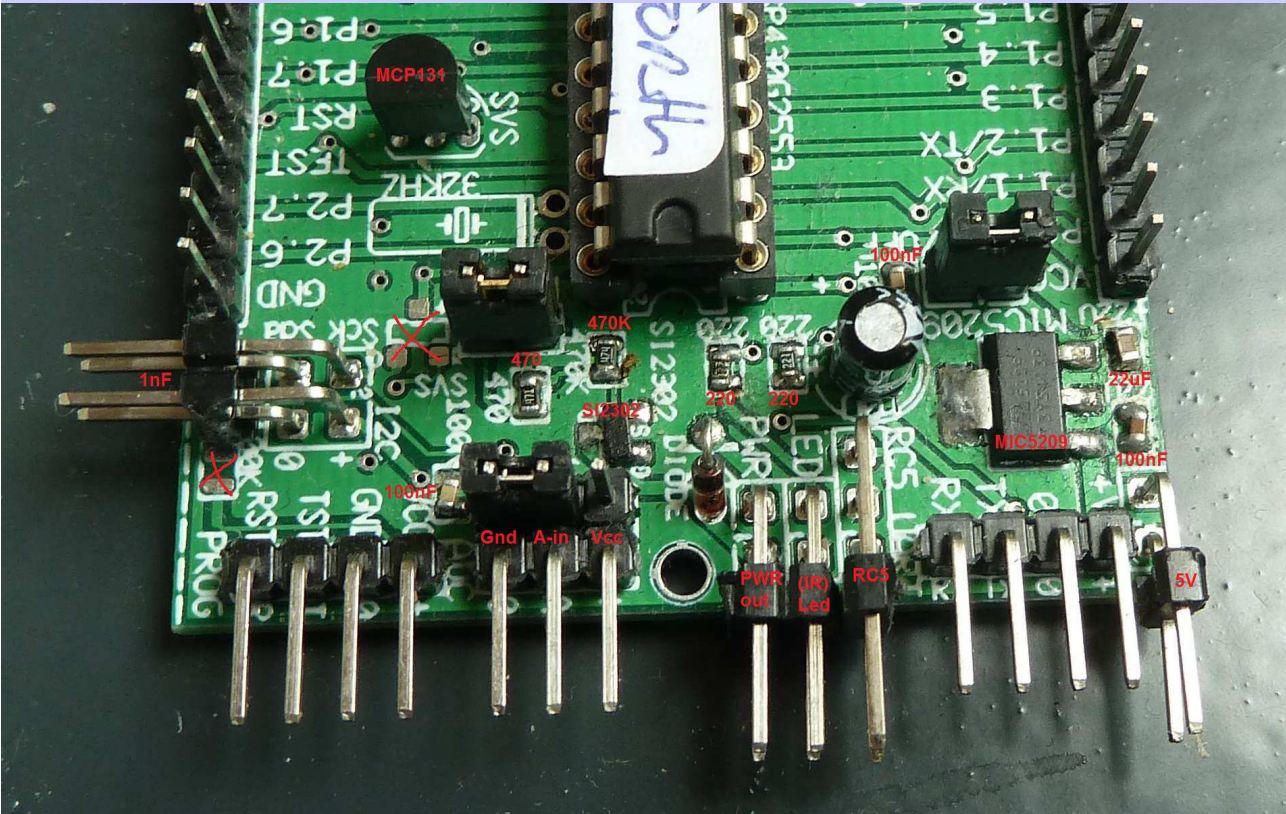

Placement (SMD) components-2

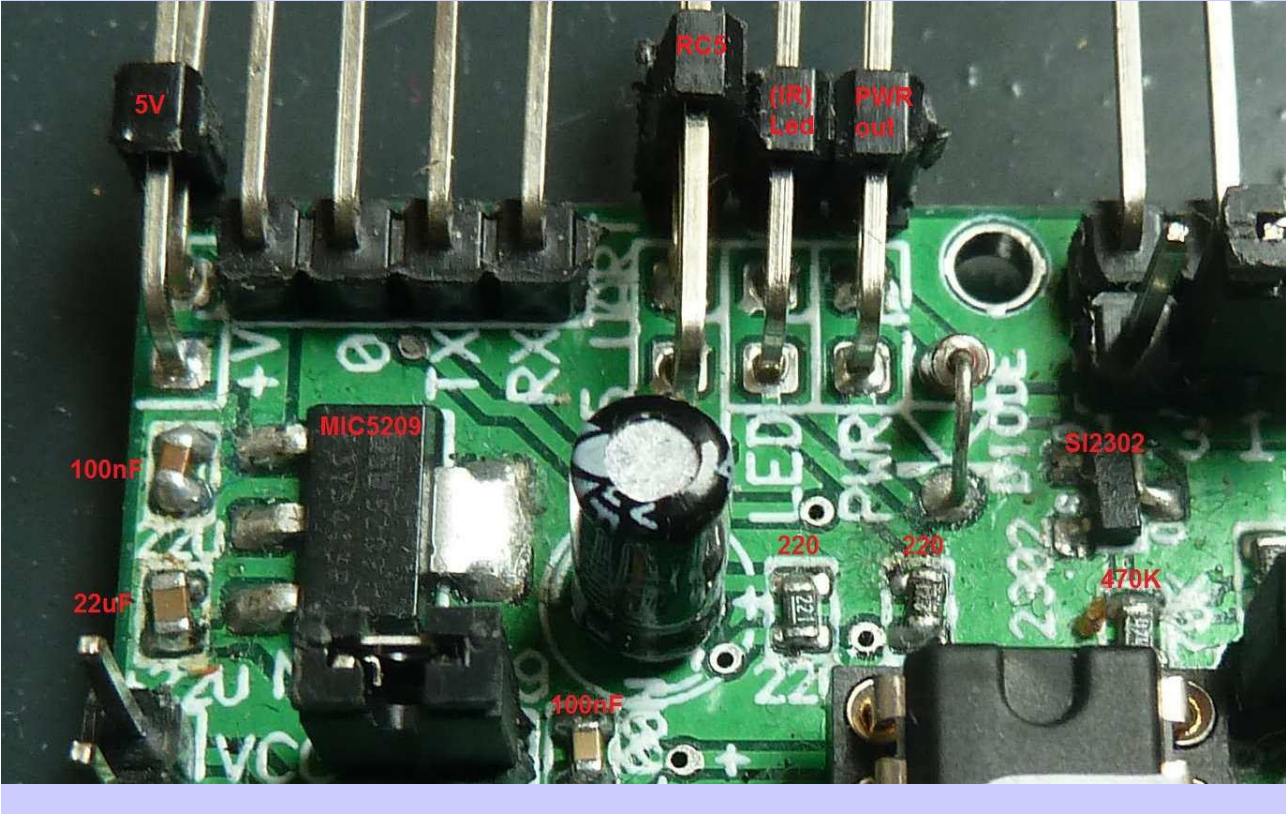

Placement (SMD) components-3

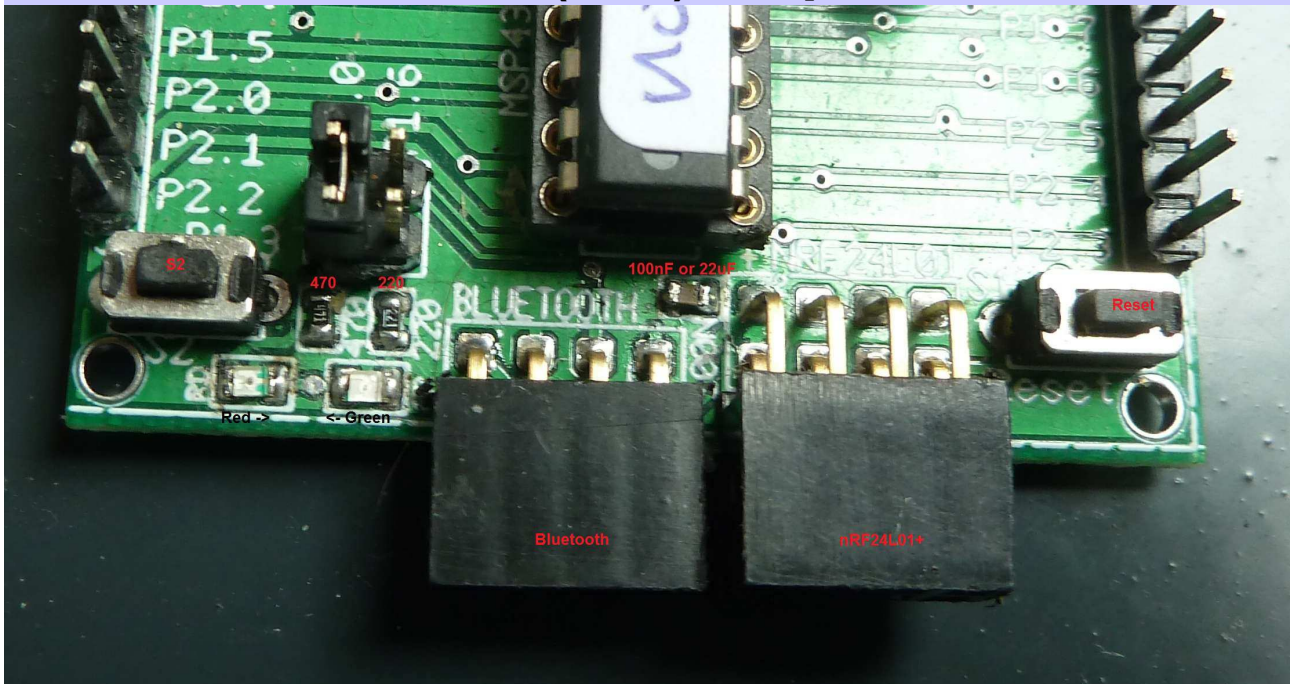

Mosfet SI2302 marking



Launchpad Shield

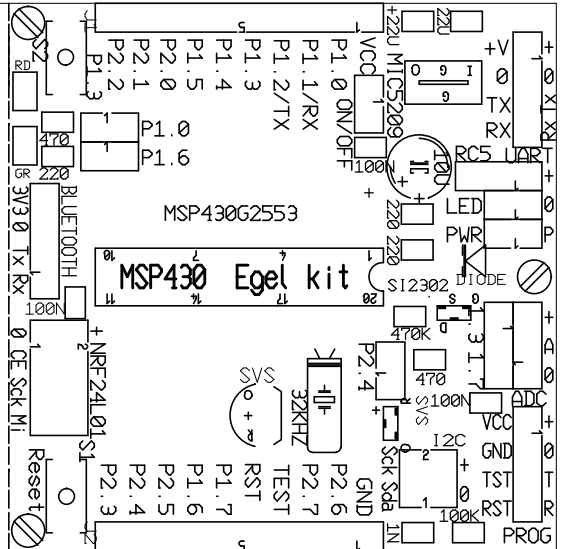
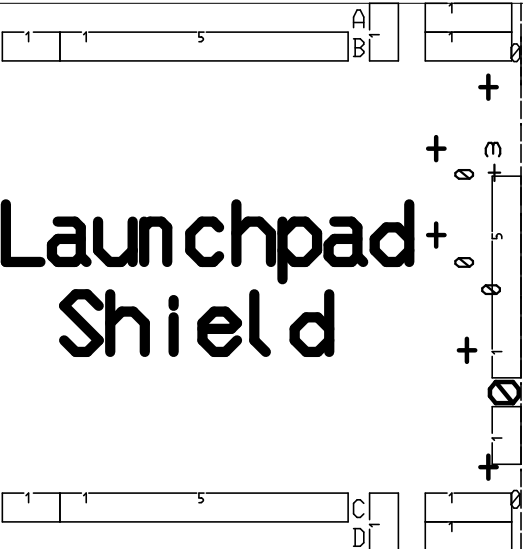

Launchpad Shield

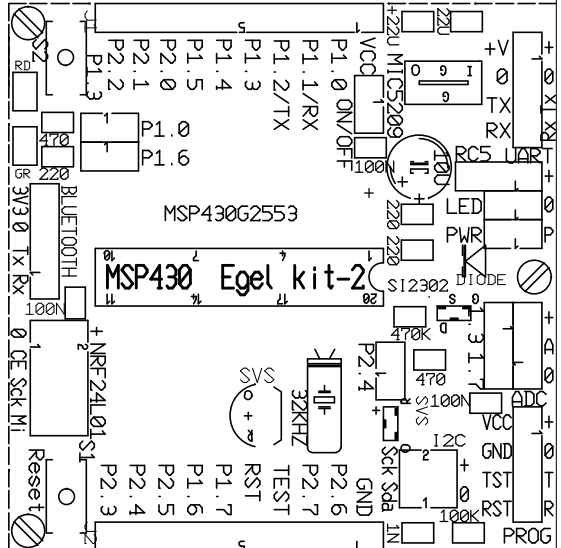
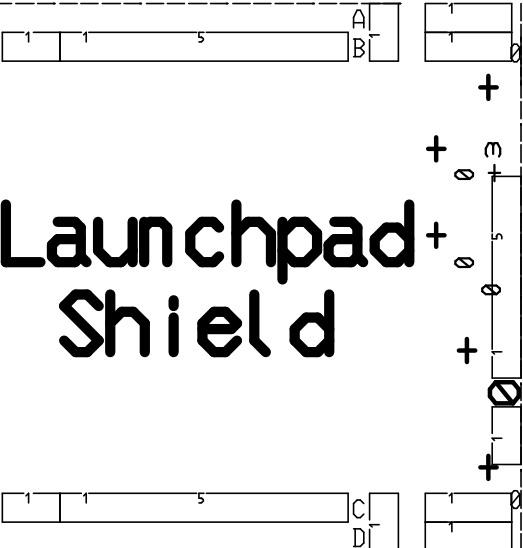

Shield

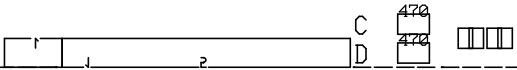
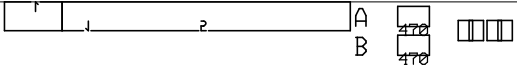

S2 W.O. 2015

+
Bluetooth
MSP430 Egel kit-V2

nRF24L01

Reset

+
RS232

+
ADC

12C
PROG

Shield

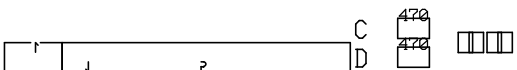
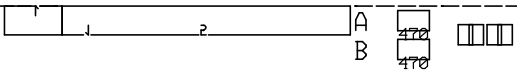

S2 W.O. 2015

+
Bluetooth
MSP430 Egel kit-V2

nRF24L01

Reset

+
RS232

+
ADC

12C
PROG

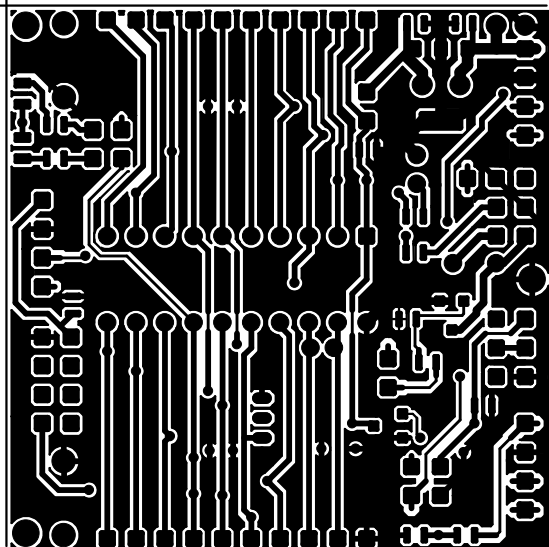
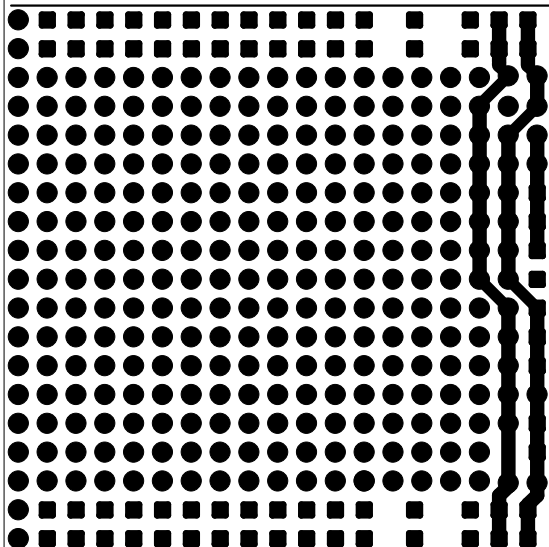
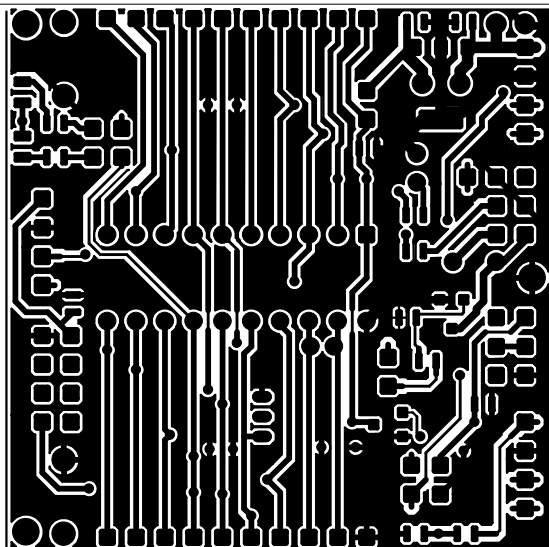
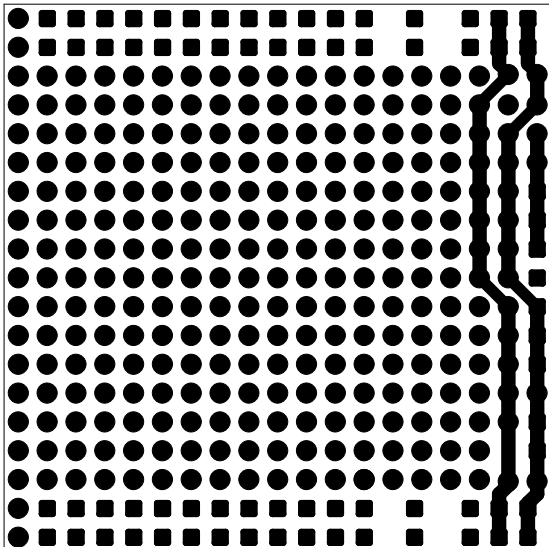

Egel shield construction

Components list:

- 1 x Egel shield printed circuit
- 4 x 10 pin female header
- 1 x 7 pin female header
- 2 x 2 pin female header
- 1 x 2 pin male header
- 2 x 3x2 pin male header
- 1 x 2 pin angle male header
- 1 x SYB-170 breadboard
- 2 x 100nF SMD 0603 capacitor
- 4 x 270Ω SMD 0603 resistor

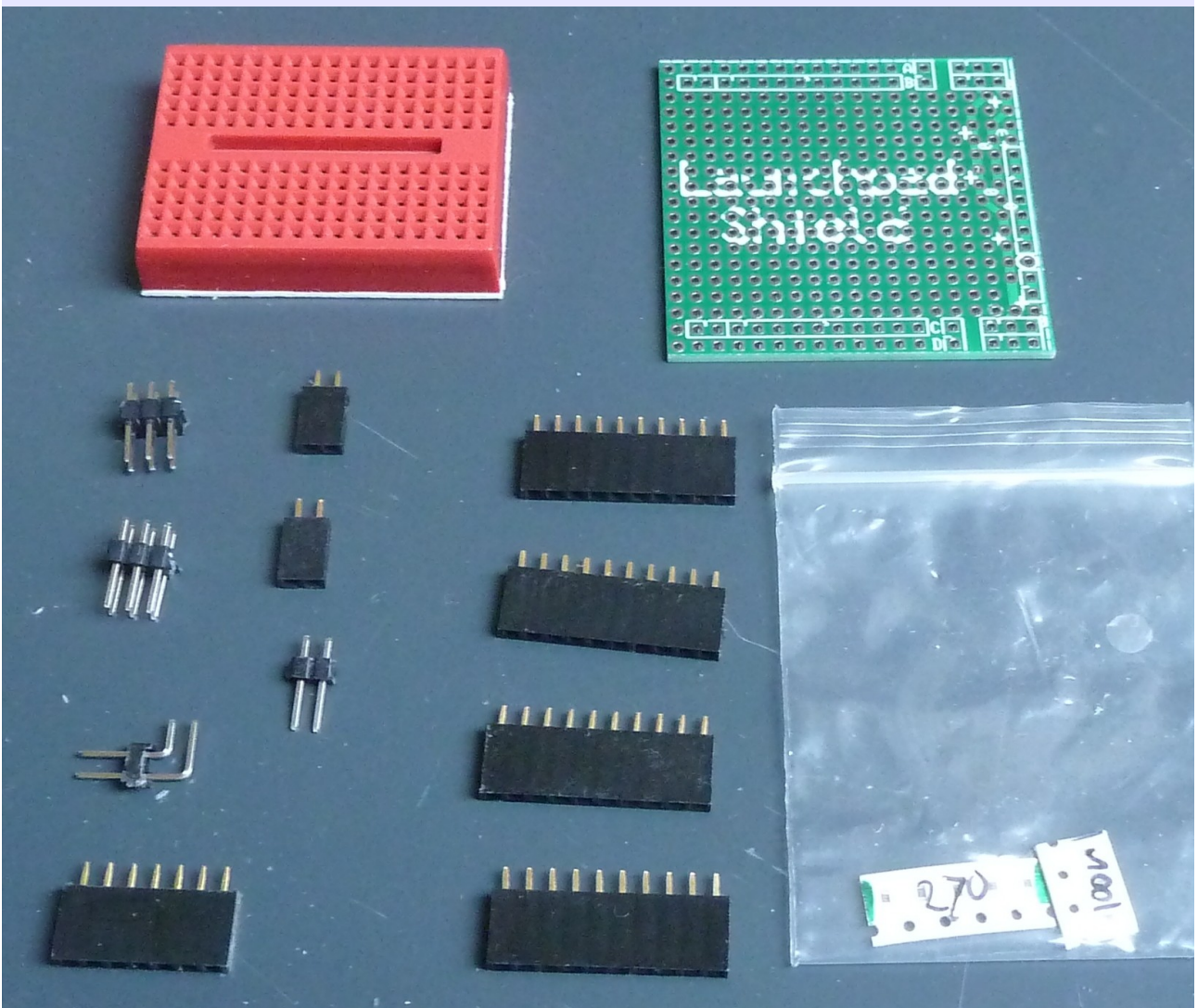

Egel shield all components

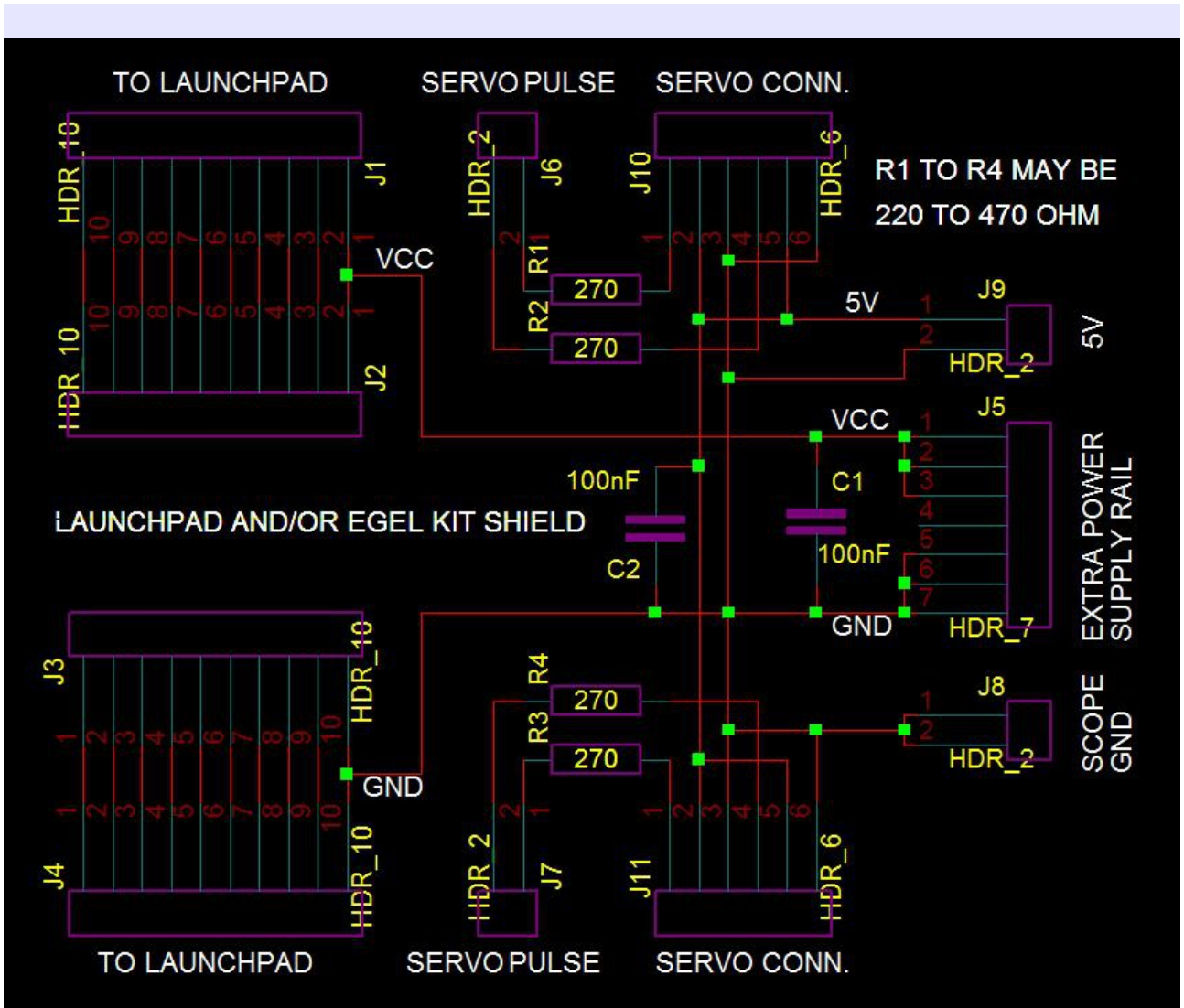

Schematic for Lanchpad/Egel kit shield



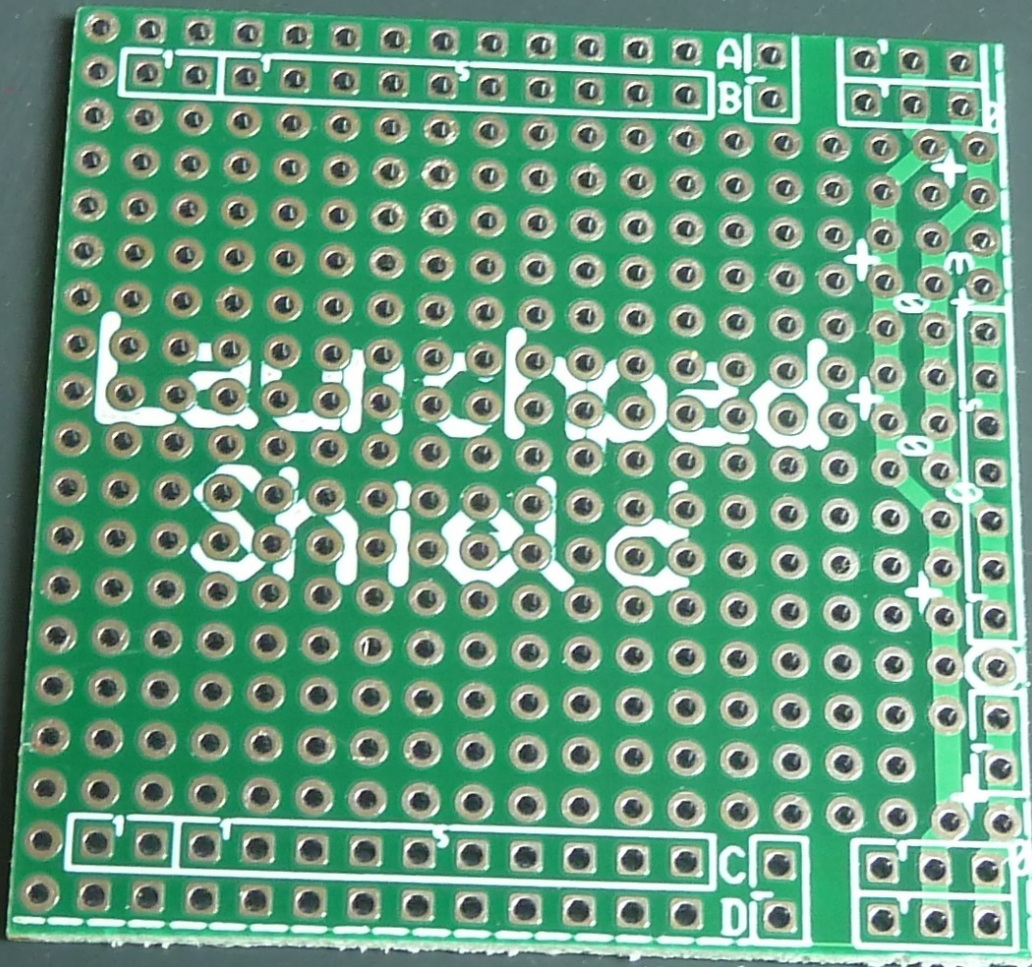

Egel shield top side empty

Use the photo's in this guide as a visual reference!

The Egel shield may be used on the MSP-EXP430G Launchpad and of course the Egel kit which basically is a clone of Launchpad. It is very usefull for experimentation and for doing the Egel project examples.

<http://noforth.bitbucket.org/site/egel%20for%20launchpad.html>

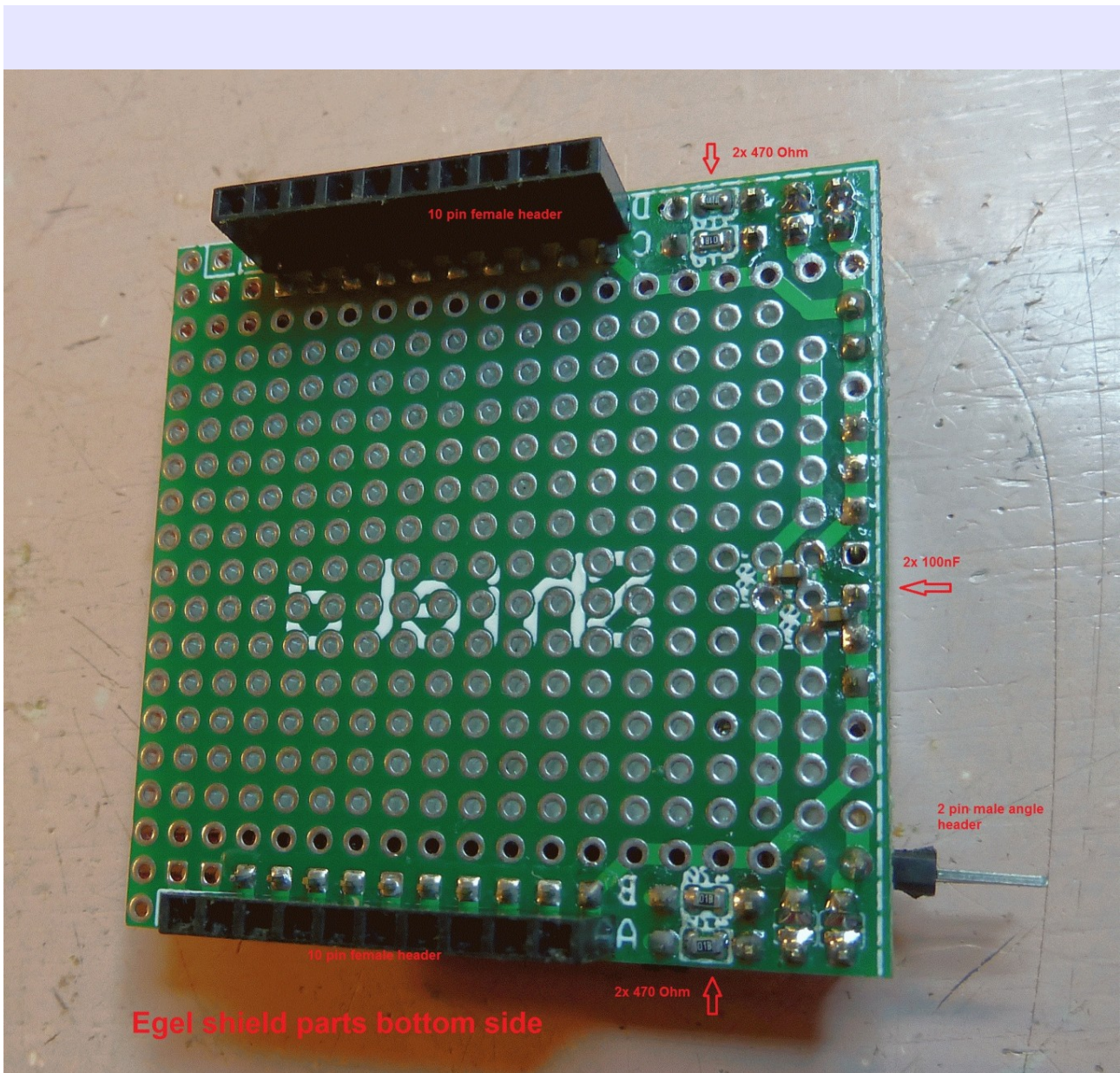

Egel shield bottom side component placing

Start with the lowest components first, in this case that are the SMD-parts. Use always enough flux or solder paste and keep them with a fingernail onto their place. If the placing is not perfect, just place the component again until it is on the right position.

Put a drop of solder on the tip of the solder iron and let it flow between the component and the solder pad. If one side is done do the other side before placing the next component.

An example on youtube: <https://www.youtube.com/watch?v=fqHleZjTaH8>

When a component is done check for short circuit and/or failed solder joints and correct them.

When all the compents are done, check again for electrical failures and correct when needed.

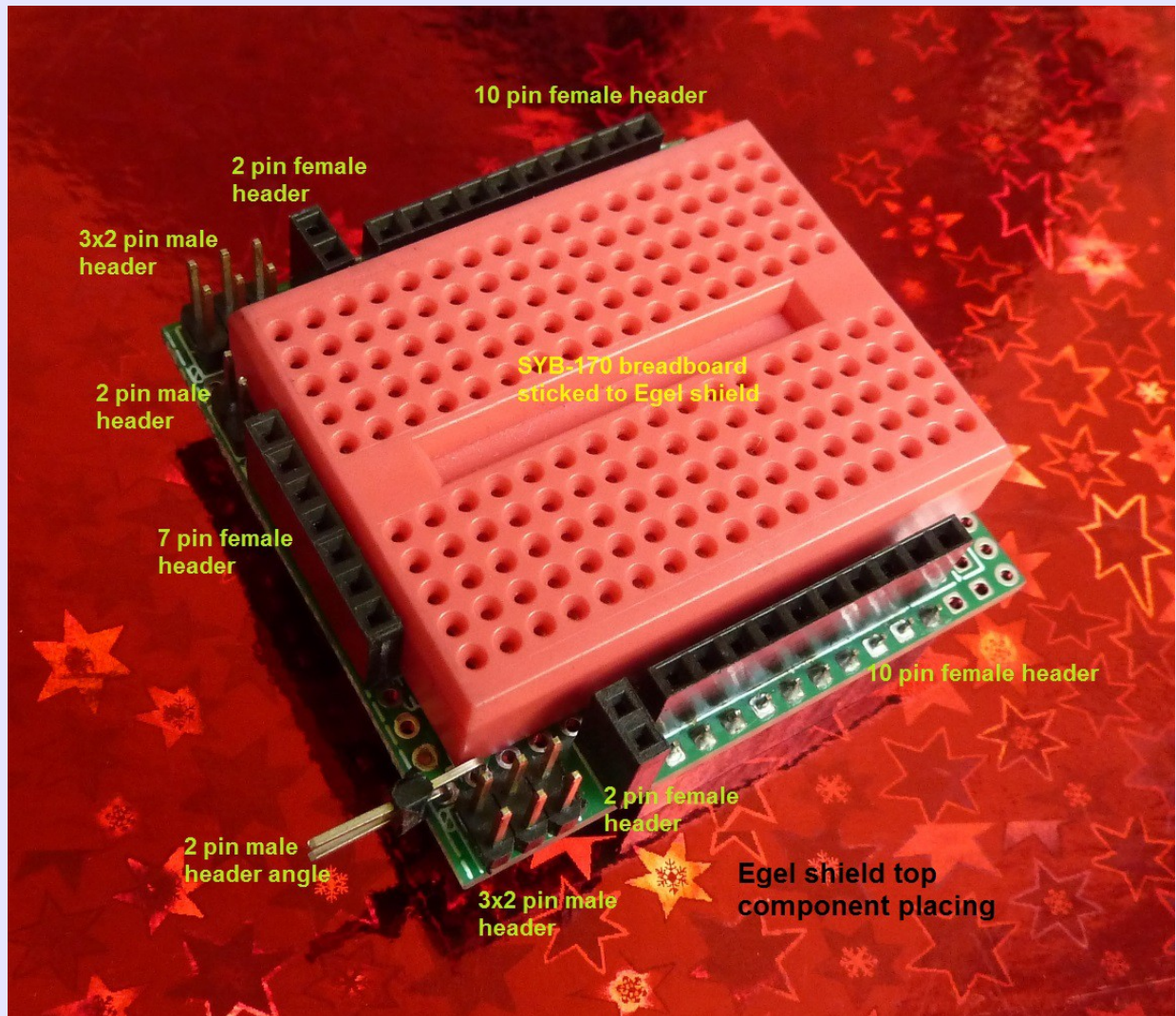

Egel shield top side component placing

Finish the bottom side first before doing the topside, on the topside start with the lowest components too, before adding the higher ones.

When a components is done check for short circuit and/or failed solder joints and correct them.

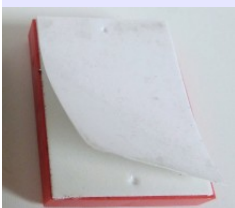

Then place the SYB-170 breadboard on the top using the sticky tape on the bottom of the SYB-170. The Egel shield is ready now.

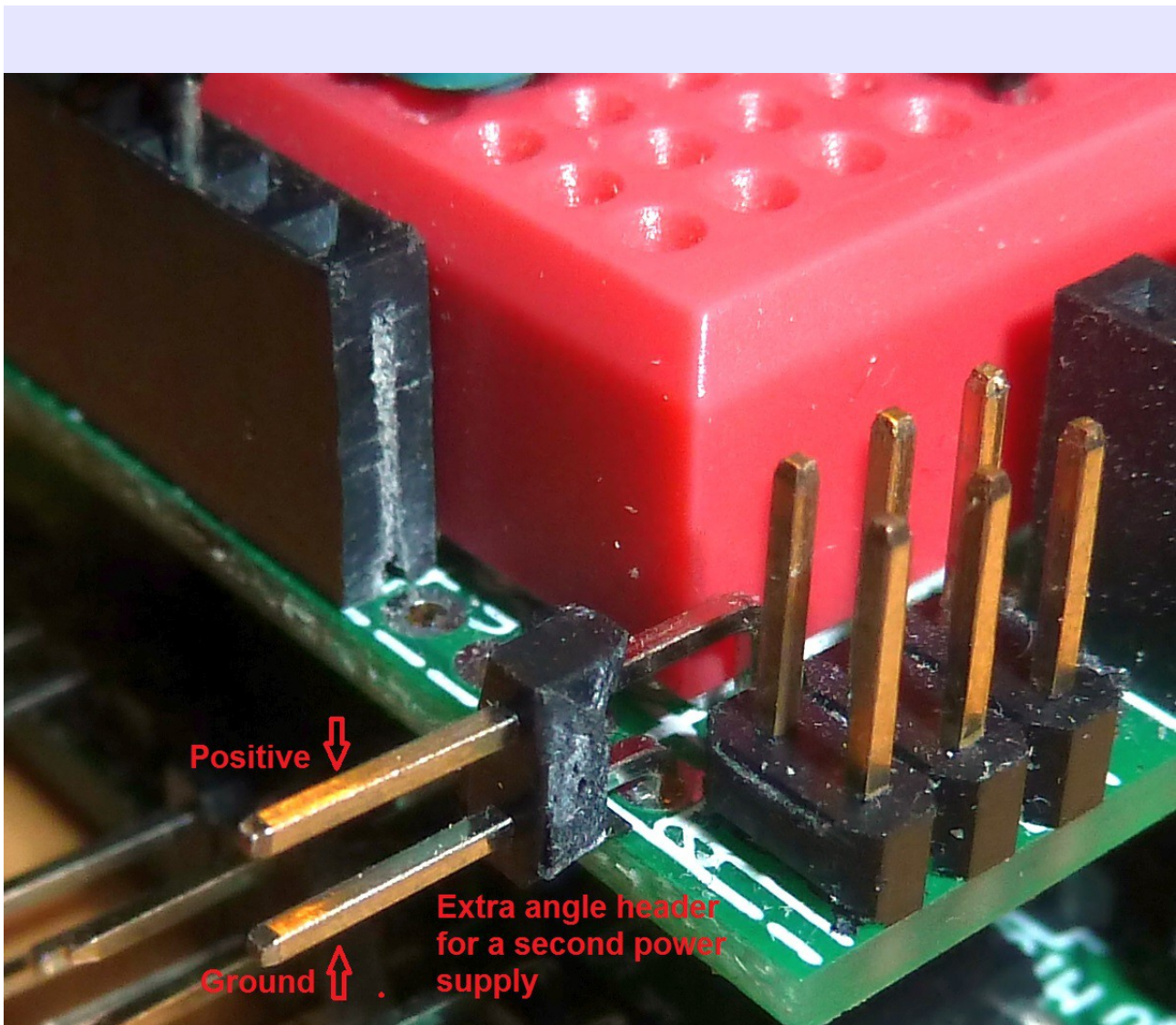

Egel shield top side extra power plug

The extra angle header is connected to both 3x2 male header strips. It may be used to connect model servo's. This power plug then serves as the power supply for these model servo's. See for a usage example chapter 110 of the egel project. This link:

<http://noforth.bitbucket.org/site/egel%20for%20launchpad.html#e110>

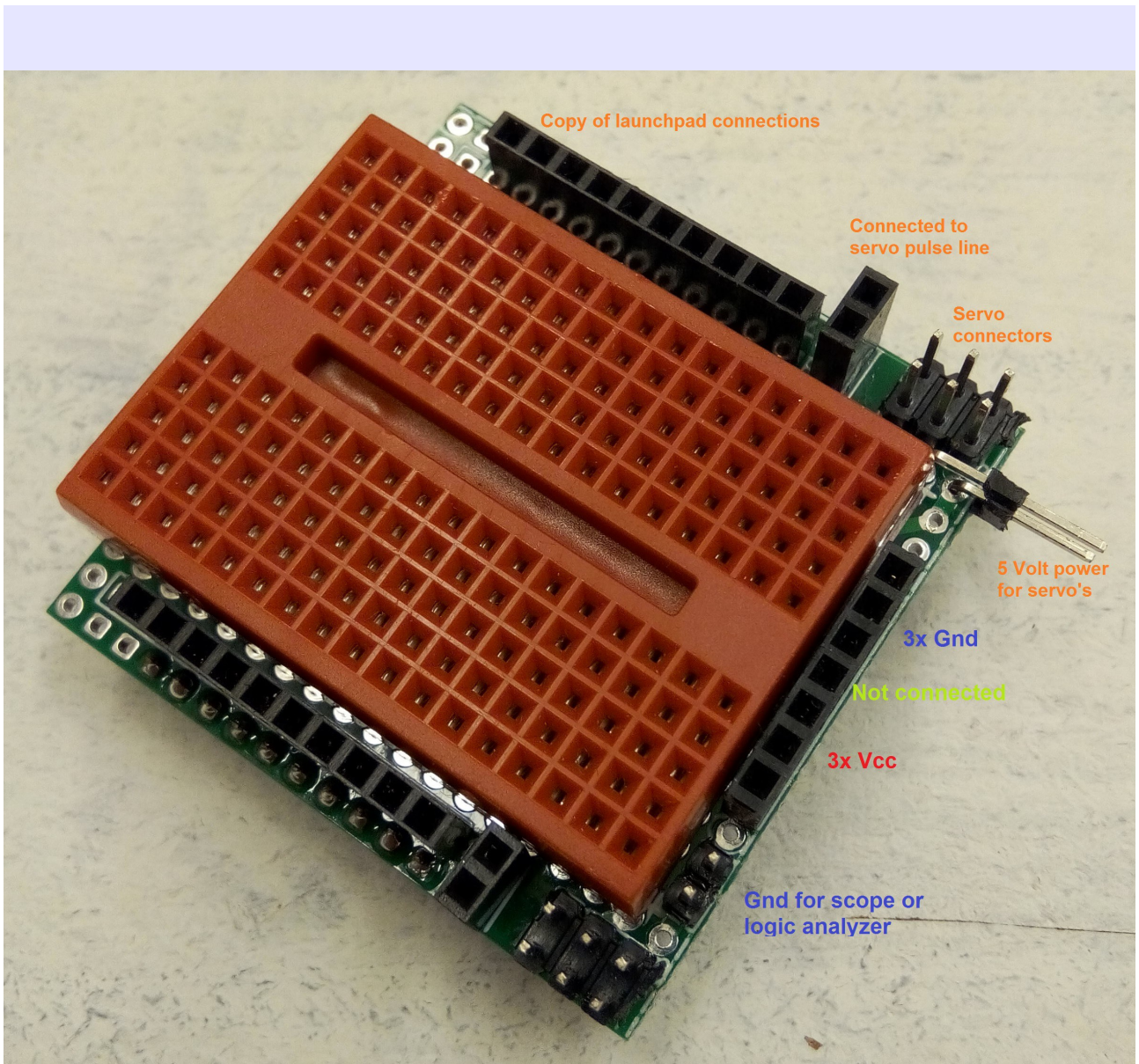

Purpose of connectors on top side of finished Egel shield

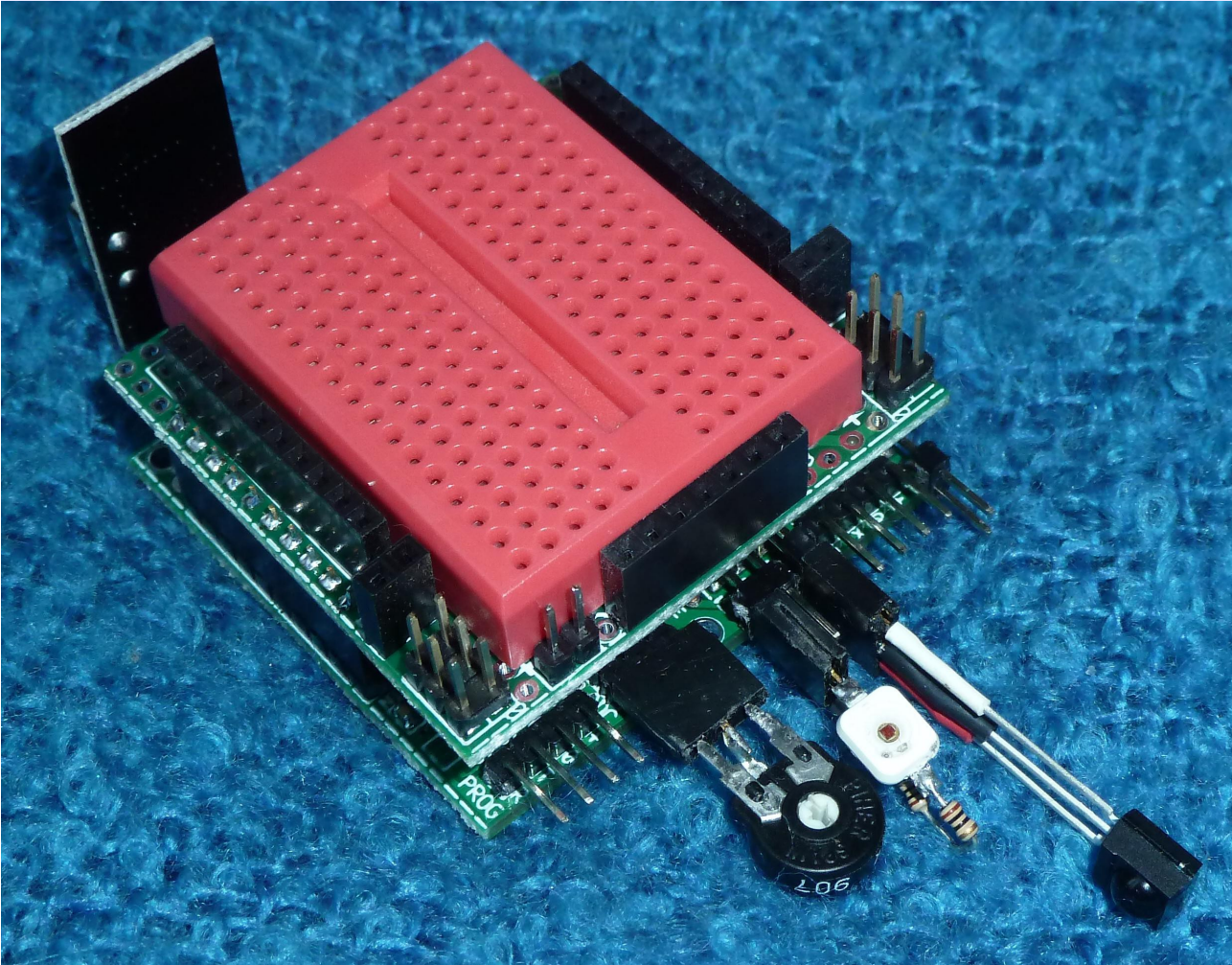

Egel shield top side finished and mounted on the Egel kit

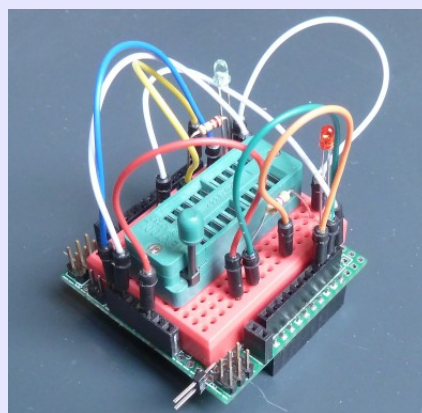

Egel shield wired as cloning programmer

Egel kit used in control of an autonomous Biped robot

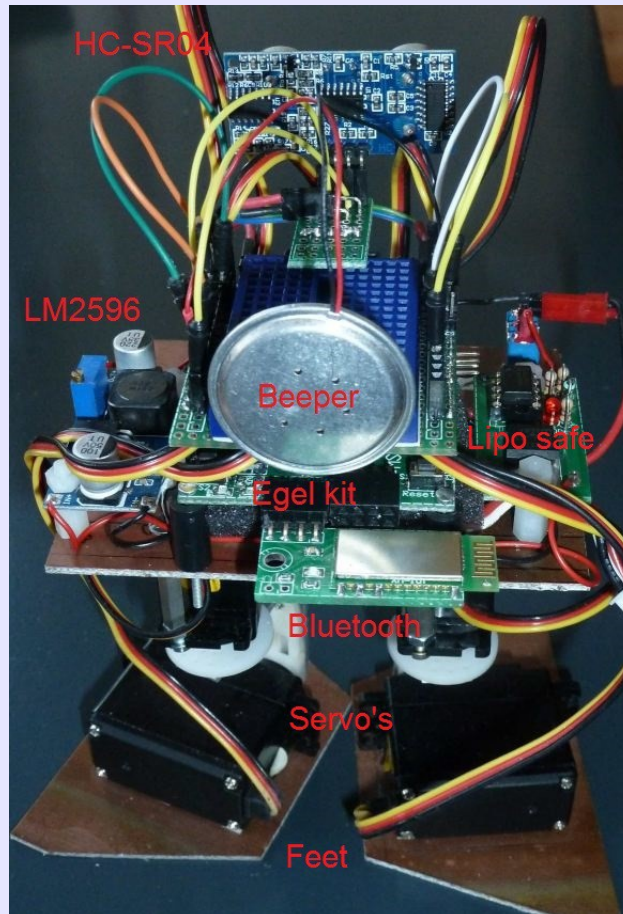

with Bluetooth,
Beeper,
US distance meter,
&
LiPo power supply.

[Link to Egel chapter about Biped](#)

General Description

The MIC5209 is an efficient linear voltage regulator with very low dropout voltage, typically 10mV at light loads and less than 500mV at full load, with better than 1% output voltage accuracy.

Designed especially for hand-held, battery-powered devices, the MIC5209 features low ground current to help prolong battery life. An enable/shutdown pin on SO-8 and TO-263-5 versions can further improve battery life with near-zero shutdown current.

Key features include reversed-battery protection, current limiting, overtemperature shutdown, ultra-low-noise capability (SO-8 and TO-263-5 versions), and availability in thermally efficient packaging. The MIC5209 is available in adjustable or fixed output voltages.

For space-critical applications where peak currents do not exceed 500mA, see the MIC5219.

Features

- Meets Intel® Slot 1 and Slot 2 requirements
- Guaranteed 500mA output over the full operating temperature range
- Low 500mV maximum dropout voltage at full load
- Extremely tight load and line regulation
- Thermally-efficient surface-mount package
- Low temperature coefficient
- Current and thermal limiting
- Reversed-battery protection
- No-load stability
- 1% output accuracy
- Ultra-low-noise capability in SO-8 and TO-263-5
- Ultra-small 3mm x 3mm MLF™ package

Applications

- Pentium II Slot 1 and Slot 2 support circuits
- Laptop, notebook, and palmtop computers
- Cellular telephones
- Consumer and personal electronics
- SMPS post-regulator/dc-to-dc modules
- High-efficiency linear power supplies

Typical Applications

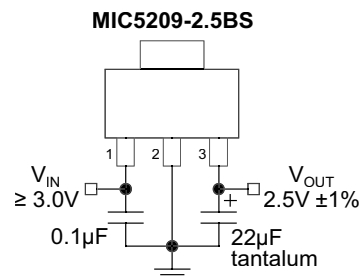

3.3V Nominal-Input Slot-1 Power Supply

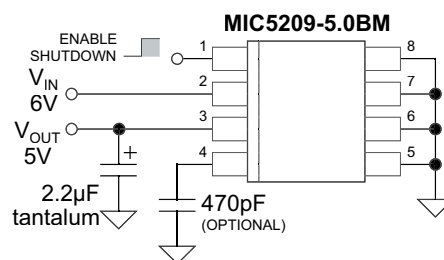

Ultra-Low-Noise 5V Regulator



TSM2302

20V N-Channel Enhancement Mode MOSFET

SOT-23



Pin assignment:

1. Gate
2. Source
3. Drain

V_{DS} = 20V

R_{DS(on)}, V_{GS} @ 4.5V, I_{DS} @ 3.6A = 65mΩ

R_{DS(on)}, V_{GS} @ 2.5V, I_{DS} @ 3.1A = 95mΩ

Features

- ◇ Advanced trench process technology
- ◇ High density cell design for ultra low on-resistance
- ◇ Excellent thermal and electrical capabilities
- ◇ Compact and low profile SOT-23 package

Block Diagram

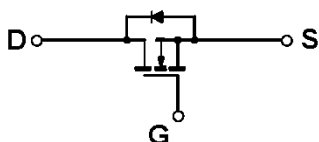

Ordering Information

Part No.	Packing	Package
TSM2302CX	Tape & Reel	SOT-23

Absolute Maximum Rating (Ta = 25°C unless otherwise noted)

Parameter	Symbol	Limit	Unit	
Drain-Source Voltage	V _{DS}	20V	V	
Gate-Source Voltage	V _{GS}	± 8	V	
Continuous Drain Current	I _D	2.4	A	
Pulsed Drain Current	I _{DM}	10	A	
Maximum Power Dissipation		Ta = 25°C	1.25	W
		Ta = 75°C	0.8	
Operating Junction Temperature	T _J	+150	°C	
Operating Junction and Storage Temperature Range	T _J , T _{STG}	- 55 to +150	°C	

Thermal Performance

Parameter	Symbol	Limit	Unit
Lead Temperature (1/8" from case)	T _L	5	S
Junction to Ambient Thermal Resistance (PCB mounted)	Rθja	100	°C/W

Note: Surface mounted on FR4 board t<=5sec.

Product Description

Specification of TACT switch Series

Temperature : $-25^{\circ}\sim+85^{\circ}\text{C}$

Rated Load :DC12V 0.1A

Contact Resistance : $\leq 0.03\Omega$

Withstand Voltage :AC250 V (50Hz) /MIN

Actuation Force : $1.3\pm 0.5\text{N}$

Insulation Resistance : $\geq 100\text{M}\Omega$

Life :100000 times

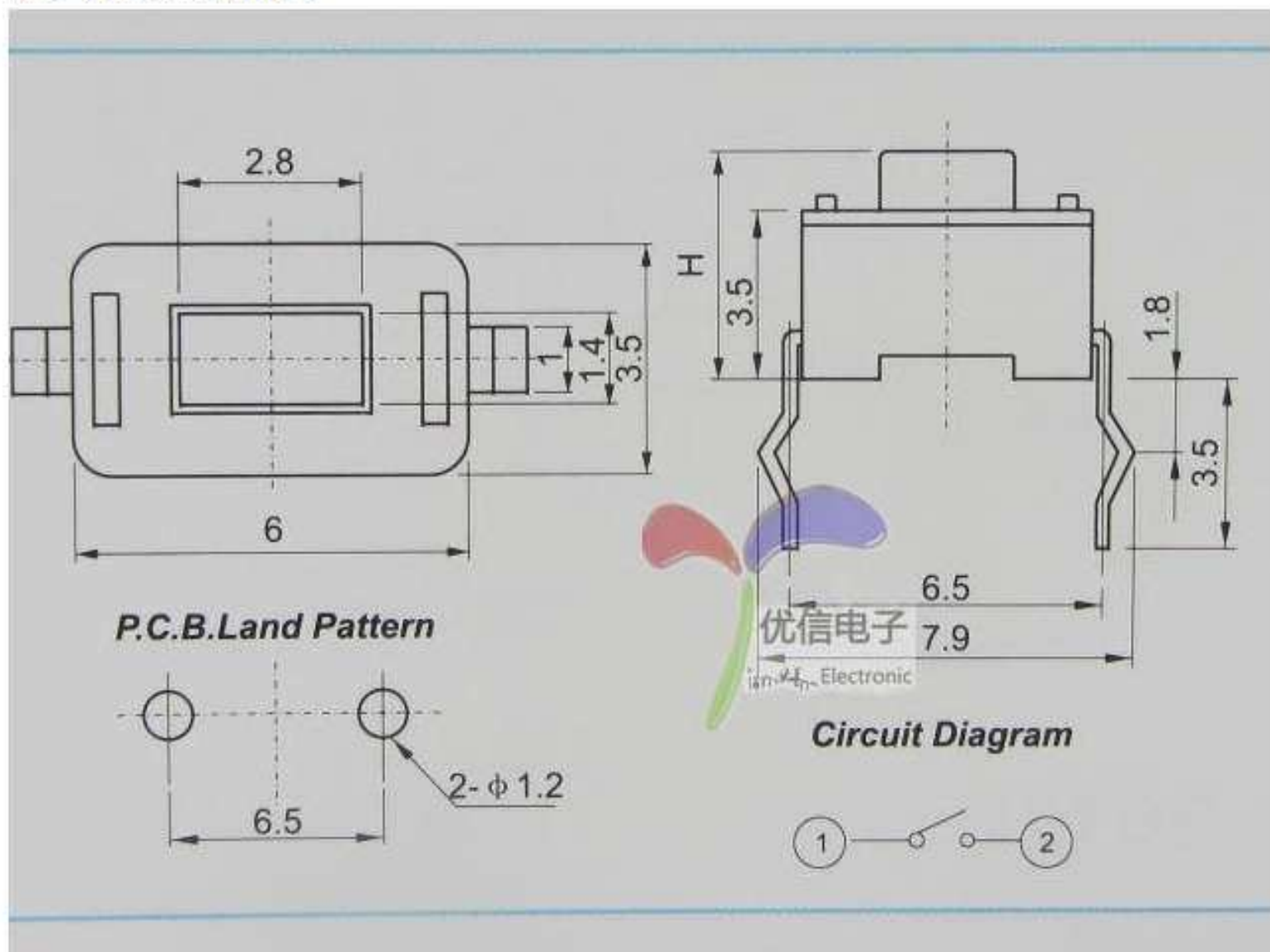

PCB:



Circuit schematics :

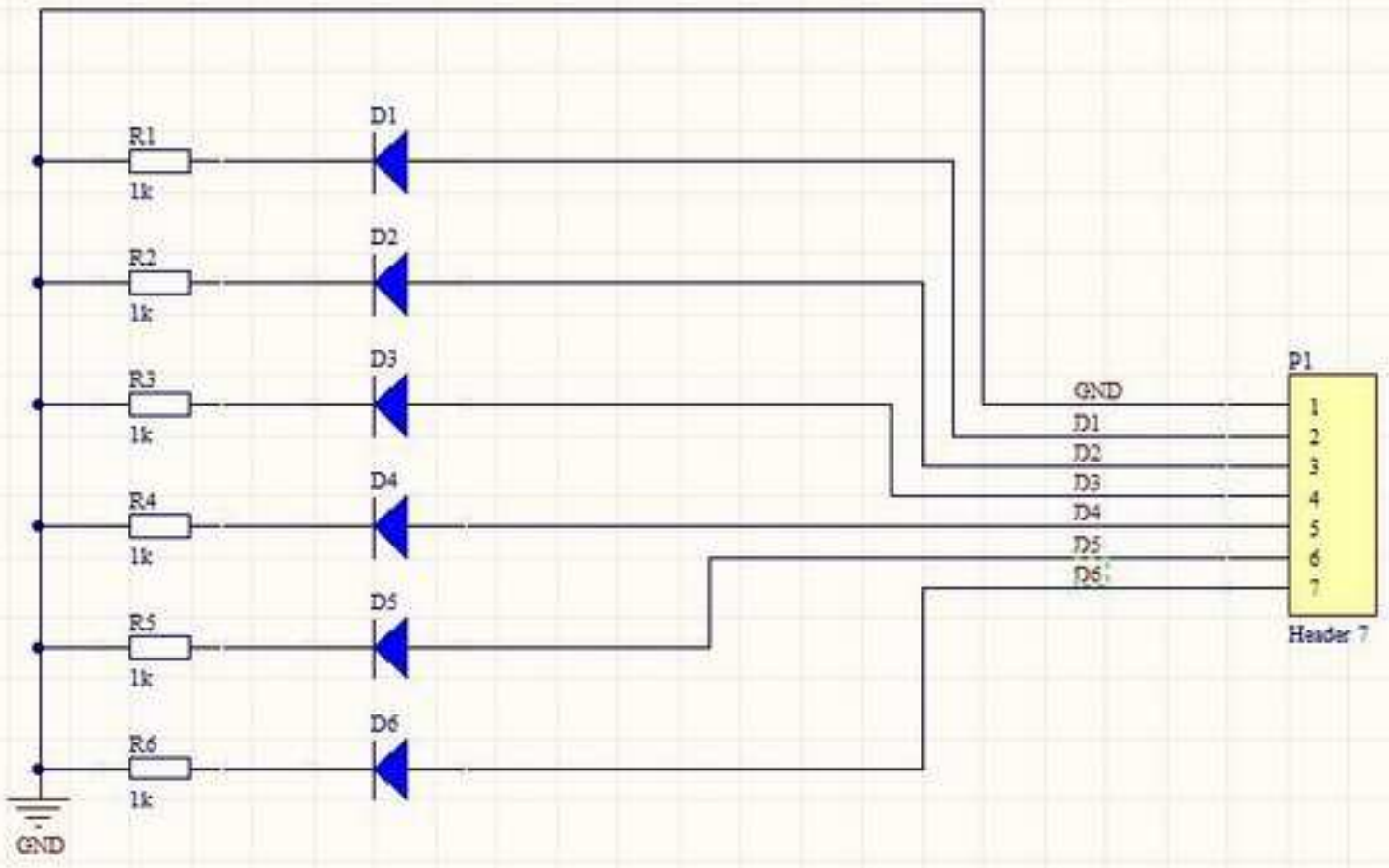

PL2303TA



支持Win XP/vista/7/8/8.1





MICROCHIP MCP102/103/121/131

Micropower Voltage Supervisors

Features

- Ultra low supply current: 1.75 μ A (steady-state max.)
- Precision monitoring options of:
 - 1.90V, 2.32V, 2.63V, 2.93V, 3.08V, 4.38V and 4.63V
- Resets microcontroller in a power-loss event
- $\overline{\text{RST}}$ pin (Active-low):
 - **MCP121**: Active-low, open-drain
 - **MCP131**: Active-low, open-drain with internal pull-up resistor
 - **MCP102** and **MCP103**: Active-low, push-pull
- Reset Delay Timer (120 ms delay, typ.)
- Available in SOT23-3, TO-92 and SC-70 packages
- Temperature Range:
 - Extended: -40°C to +125°C (except MCP1XX-195)
 - Industrial: -40°C to +85°C (MCP1XX-195 only)
- Pb-free devices

Applications

- Critical Microcontroller and Microprocessor Power-monitoring Applications
- Computers
- Intelligent Instruments
- Portable Battery-powered Equipment

General Description

The MCP102/103/121/131 are voltage supervisor devices designed to keep a microcontroller in reset until the system voltage has reached and stabilized at the proper level for reliable system operation. Table 1 shows the available features for these devices.

TABLE 1: DEVICE FEATURES

Device	Output		Reset Delay (typ)	Package Pinout (Pin # 1, 2, 3)	Comment
	Type	Pull-up Resistor			
MCP102	Push-pull	No	120 ms	$\overline{\text{RST}}$, V_{DD} , V_{SS}	
MCP103	Push-pull	No	120 ms	V_{SS} , $\overline{\text{RST}}$, V_{DD}	
MCP121	Open-drain	External	120 ms	$\overline{\text{RST}}$, V_{DD} , V_{SS}	
MCP131	Open-drain	Internal (~95 k Ω)	120 ms	$\overline{\text{RST}}$, V_{DD} , V_{SS}	
MCP111	Open-drain	External	No	V_{OUT} , V_{SS} , V_{DD}	See MCP111/112 Data Sheet (DS21889)
MCP112	Push-Pull	No	No	V_{OUT} , V_{SS} , V_{DD}	See MCP111/112 Data Sheet (DS21889)

Package Types

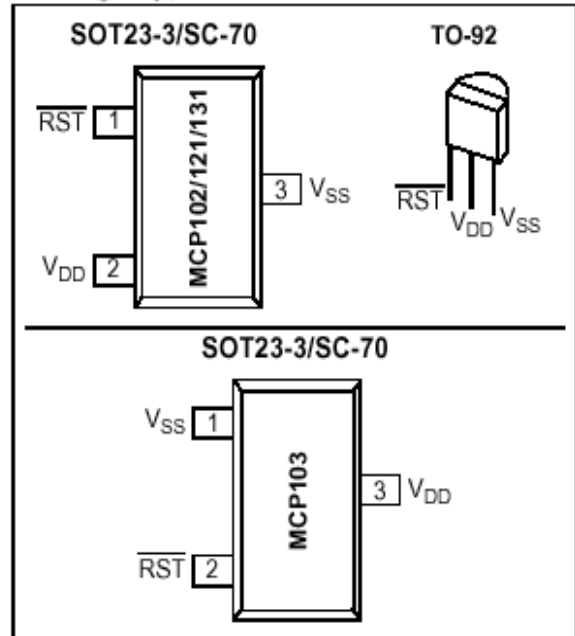

Block Diagram

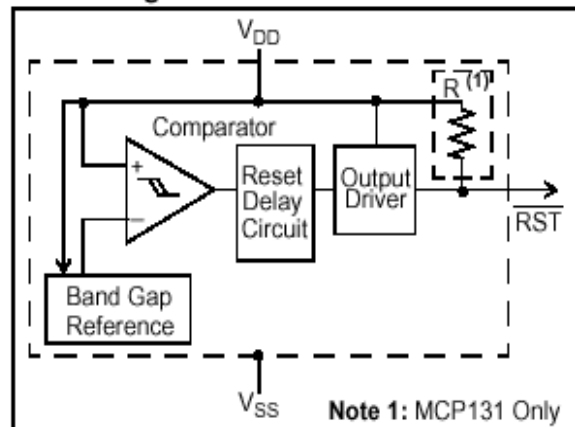



IR Receiver Modules for Remote Control Systems

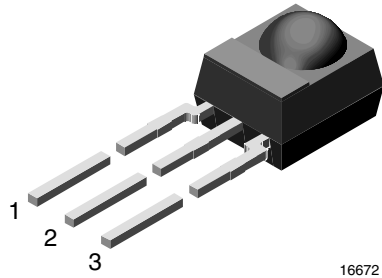

16672

MECHANICAL DATA

Pinning for TSOP341..., TSOP343..., TSOP345...:

1 = OUT, 2 = GND, 3 = V_S

Pinning for TSOP321..., TSOP323..., TSOP325...:

1 = OUT, 2 = V_S, 3 = GND

FEATURES

- Very low supply current
- Photo detector and preamplifier in one package
- Internal filter for PCM frequency
- Improved shielding against EMI
- Supply voltage: 2.5 V to 5.5 V
- Improved immunity against ambient light
- Insensitive to supply voltage ripple and noise
- Material categorization:
for definitions of compliance please see www.vishay.com/doc?99912



RoHS
COMPLIANT
HALOGEN
FREE
GREEN
(5-2008)

DESCRIPTION

These products are miniaturized receivers for infrared remote control systems. A PIN diode and a preamplifier are assembled on a lead frame, the epoxy package acts as an IR filter.

The demodulated output signal can be directly connected to a microprocessor for decoding. The TSOP321..., TSOP341.. are legacy products compatible with all common IR remote control data formats. The TSOP323..., TSOP343 are optimized to better suppress spurious pulses from energy saving fluorescent lamps. The TSOP325..., TSOP345.. have an excellent noise suppression. They are immune to dimmed LCD backlighting and any fluorescent lamps. AGC3 and AGC5 may also suppress some data signals in case of continuous transmission. Between these three receiver types, the TSOP323..., TSOP343.. are preferred. Customers should initially try the TSOP323..., TSOP343.. in their design.

This component has not been qualified according to automotive specifications.

PARTS TABLE							
AGC		LEGACY, FOR SHORT BURST REMOTE CONTROLS (AGC1)		NOISY ENVIRONMENTS AND SHORT BURSTS (AGC3)		VERY NOISY ENVIRONMENTS AND SHORT BURSTS (AGC5)	
Carrier frequency	30 kHz	TSOP34130	TSOP32130	TSOP34330	TSOP32330	TSOP34530	TSOP32530
	33 kHz	TSOP34133	TSOP32133	TSOP34333	TSOP32333	TSOP34533	TSOP32533
	36 kHz	TSOP34136	TSOP32136	TSOP34336	TSOP32336 (1)(2)	TSOP34536	TSOP32536(1)(2)
	38 kHz	TSOP34138	TSOP32138	TSOP34338	TSOP32338 (3)(4)(5)(6)	TSOP34538	TSOP32538 (3)(4)(5)
	40 kHz	TSOP34140	TSOP32140	TSOP34340	TSOP32340	TSOP34540	TSOP32540
	56 kHz	TSOP34156	TSOP32156	TSOP34356	TSOP32356	TSOP34556	TSOP32556
Package		Mold					
Pinning		1 = OUT, 2 = GND, 3 = V _S	1 = OUT, 2 = V _S , 3 = GND	1 = OUT, 2 = GND, 3 = V _S	1 = OUT, 2 = V _S , 3 = GND	1 = OUT, 2 = GND, 3 = V _S	1 = OUT, 2 = V _S , 3 = GND
Dimensions (mm)		6.0 W x 6.95 H x 5.6 D					
Mounting		Leaded					
Application		Remote control					
Best remote control code		(1) MCIR (2) RCMM (3) Mitsubishi (4) RECS-80 Code (5) r-map (6) XMP-1, XMP-2					

